

De espiral retráctil con combinación 4 dígitos cabeza metálica.

Retractable spire cable padlock with combination and metal head



1 m
Ø=8 mm

CCE-8100

Flexible inviolable con cubierta de acero

Flexible with steel cover



2 Llaves de seguridad
2 Security keys.

1 m
Ø=25.4 mm

CCFI-1150

Con Candado

Flexible with steel cover



Uso rudo
Heavy duty

3 llaves de seguridad
3 security keys

Cadena

CM-90

Candado para motocicleta freno de disco

Scooter disc-brake lock

NUEVO



- Ideal para motocicletas medianas y scooters.
- Vástago de 5,5 mm de grosor.
- Incluye cable para recordar que el candado está instalado



CFD-05

Candado para motocicleta freno de disco

Motorcycle disc-brake lock

NUEVO



- Ideal para motocicletas grandes y medianas.
- Vástago de 10 mm de grosor.
- Incluye cable para recordar que el candado está instalado.



CFD-10

De seguridad doble lazo

NUEVO



1 m
Ø=120 mm

CSDL-12

Flexible HD 4 llaves de seguridad

HD flexible - 4 security keys



1.5 m
Ø=25.4 mm

C-4613

Flexible tipo doble lazo

Flexible double loop cable



1.5 m
Ø=25.4 mm

CSDL-15

Flexible tipo doble lazo

Flexible double loop cable



3 m
Ø=25.4 mm

CSDL-30

Rígido de acero tipo U 2 Llaves de seguridad

U-type rigid steel padlock - 2 security keys



C-1824

Cinchos de plástico CABLE TIES

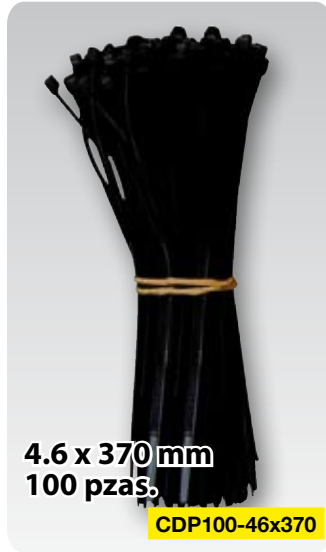
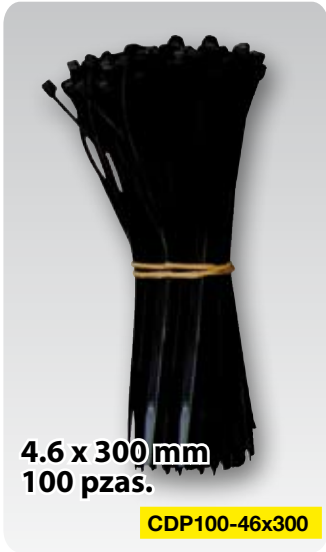
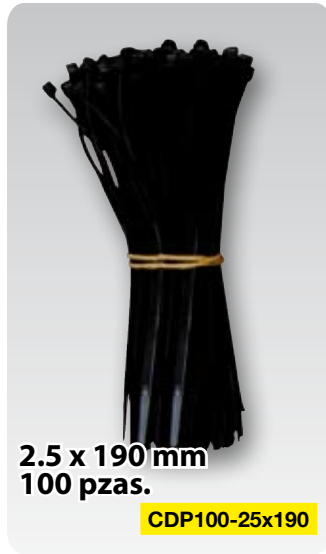

Bote de plástico.
Plastic canister

1000 pzas.

CDP-1000

Incluye:
Includes:

- A)
- B)
- C)

A) • 2.5 x 100 mm (50 pzas)
B) • 4.6 x 200 mm (400 pzas)
C) • 4.7 x 300 mm (100 pzas)



Cinturones Tensores-Ganchos *TIE DOWNS*

Eslinga remolcadora

Tow rope



2"
1.5 t
4 m

SCT-1

Ganchos tensores 2 pzas

Super tie down straps 2 pieces



Acero templado de 8 mm con recubrimiento de vinil
8 mm steel hooks with vinyl covering

1"
545 kg
1.8 m

T-2

Ganchos tensores 4 pzas

Super tie down straps 4 pieces



1"
1 t
1.8 m

T-3

Ganchos tensores con matraca 4 pzas

Super tie down with ratchet straps 4 pieces



1"
450 kg
4.5 m

T-3M

Cinturón para sujetar carga

Load Holding Tie Down



2"
1.5 t
4.5 m

TDB-45

Estructura de acero templado con acabado tropicalizado.
Dispositivo manual de tensión. Ganchos reforzados en cada extremo
Steel construction, with galvanized finish. Manual tension device. Reinforced hooks on each end

Cinturón para sujetar carga

Load Holding Tie Down

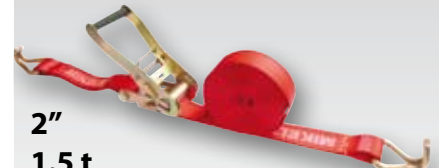

2"
1.5 t
9 m

TDB-90

Banda para Malacate Tensor

Truck Winch Strap



4"
3 t
9 m

BMT-4

Cintas para Empaque *PACKING TAPE*

LÍNEA NUEVA

Cinta Transparente

Transparent Packing Tape



44 mm
40 m



CTI-40

Cinta Canela

Brown Packing Tape



44 mm
40 m



CCI-40

Embudos Plásticos con Filtro *PLASTICS FUNELS WITH FILTER*

Embudo de plástico con filtro

Plastic funnel with filter



5"



EPF-5

Filtro de acero inoxidable
Stainless steel filter

Embudo de plástico con filtro

Plastic funnel with filter



7"



EPF-7

Eslingas *TIE DOWNS*

4 m
4 t
2"



S2-4M2

6 m
4 t
2"



S2-6M2

8 m
4 t
2"



S2-8M2

10 m
4 t
2"



S2-10M2

4 m
6 t
3"



S3-4M3

6 m
6 t
3"



S3-6M3

8 m
6 t
3"



S3-8M3

10 m
6 t
3"



S3-10M3

4 m
8 t
4"



S4-4M4

6 m
8 t
4"



S4-6M4

8 m
8 t
4"



S4-8M4

10 m
8 t
4"







S4-10M4

1 m
1 t
1"

NUEVO

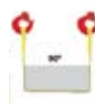

S1-1M1

ANCHO	KILOGRAMOS VERTICAL	 KG CON TENSIÓN	 KG EN CANASTA 90°	 KG EN CANASTA 60°	 KG EN CANASTA 45°	 KG EN CANASTA 30°
1 PULGADA	1000	800	2000	1600	1400	1000
2 PULGADAS	2,000	1,600	4,000	3,400	2,800	2,000
3 PULGADAS	3,000	2,400	6,000	5,100	4,200	3,000
4 PULGADAS	4,000	3,200	8,000	6,800	5,600	4,000



Engrapadora *STAPLER*

Engrapadora

Stapler

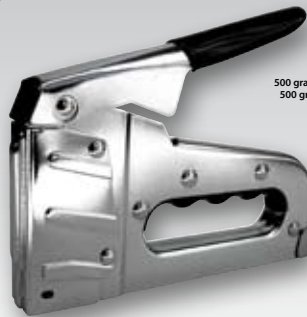

Incluye
500 grapas 5/16"
500 grapas 1/2"

ETP-1000

Grapas 8 mm 1000 pzas

Staples



5/16"

GRA-516

Grapas 13 mm 1000 pzas

Staples



1/2"

GRA-12

Flexómetros *MEASURING TAPES*

Contra Impacto

Impact Resistant



Impresión de medidas
en ambas caras.
Tape printed in both sides

3 m

FC-3

Contra Impacto

Impact Resistant



Impresión de medidas
en ambas caras.
Tape printed in both sides

5 m

FC-5

Premier Contra Impacto

Premier Impact Resistant



Impresión de medidas
en ambas caras.
Tape printed in both sides

3 m

Punta Magnética
Magnetic tip

FP-300

Premier Contra Impacto

Premier Impact Resistant



Impresión de medidas
en ambas caras.
Tape printed in both sides

5 m

Punta Magnética
Magnetic tip

FP-500

Premier Contra Impacto

Premier Impact Resistant



Impresión de medidas
en ambas caras.
Tape printed in both sides

7,5 m

Punta Magnética
Magnetic tip

FP-750

Impermeable *RAINCOAT*

Impermeable tipo manga

Raincoat



IMA-06

Lentes *GOOGLES*

Lentes de protección para trabajo.

Protective eyeglasses



Cuenta con 4 respiraderos.
With 4 vents

LTV-1

Guantes para trabajo WORKING GLOVES

Algodón con puntos de PVC

Cotton with PVC dots



GPVC-2

Carnaza con loneta

Split cowhide palm and canvas



GCL-2

Nitrilo con forro de algodón

Nitrile dipped cotton gloves



GNFA-2

De carnaza y Loneta Reforzado

Heavy duty split cowhide palm and canvas



GCLR-2

De carnaza Trabajo Pesado

Heavy Duty cowhide glove



GCTP-2

De carnaza Trabajo Pesado Cortos

Short heavy duty cowhide glove



GCURC-2

De carnaza Trabajo Pesado Largos

Long heavy duty cowhide glove



GCURL-2

Para Mecánico piel sintética Medianos

Mechanic's gloves, medium size

NUEVO



GM-2

Para Mecánico piel sintética Grandes

Mechanic's gloves, large size

NUEVO



GM-2G



Guantes para trabajo WORKING GLOVES

Profesionales para mecánico acolchonados Medianos

Professional mechanic's gloves, medium size



GMP-2

Profesionales para mecánico acolchonados Grandes

Professional mechanic's gloves, large size



GMP-2G

Nylon con espuma de nitrilo Chicos

Foam nitrile coated nylon gloves, small size

NUEVO



GEN-2S

Nylon con espuma de nitrilo Medianos

Foam nitrile coated nylon gloves, medium size

NUEVO



GEN-2M

Nylon con espuma de nitrilo Grandes

Foam nitrile coated nylon gloves, large size

NUEVO



GEN-2G

Juegos de Herramientas TOOL KITS

Juego de dados y matraca de 1/2"

1/2" Socket set



9 Dados estándar y 9 milimétricos 1/4" y 3/8". 9 Standard & 9 metric.

19 pzas.

JAC-1219

Juego de dados y matraca de 3/8"

3/8" socket set



10 Dados estándar y 10 milimétricos cuadro 1/4". 10 Standard & 10 metric.

21 pzas.

JAC-3821

Juego de dados y accesorios

Socket and accessories tool set



Incluye estuche para crear tu propio kit.

Cuadros 1/4" & 3/8" Standard & metric.

50 pzas.

JDA-50

Juego de dados y accesorios

Socket and accessories tool set



Incluye estuche para crear tu propio kit.

Dados estándar y métricos cuadro 1/4", 3/8" y 1/2". 1/4", 3/8" & 1/2" Standard & metric.

110 pzas.

JDA-110

Kit de herramientas

Tool kit



Incluye estuche para crear tu propio kit.

140 pzas.

KIT-3

Juego de autoclé Cromo vanadio

Chrome vanadium socket set



Cuadros 1/2", 1/4" & 3/8" Standard & metric.

100 pzas.

JAC-100

Multiherramientas *MULTITOOLS*

Empaque de Regalo

Gift Pack



9 en 1

MHER-91

Multiherramienta de Bolsillo

Mini Pocket Multitool



Largo / Length: 2"
Incluye funda de nylon.
Includes nylon pouch.

10 en 1

MHB-101

Navaja Multiusos

Multipurpose Knife



Largo / Length: 4.5"
Incluye funda de nylon.
Includes nylon pouch.

13 en 1

MH-131

Mango Ergonómico

Ergonomic Handle



13 en 1

MHE-131

Mango Antiderrapante

Anti-slip Handle

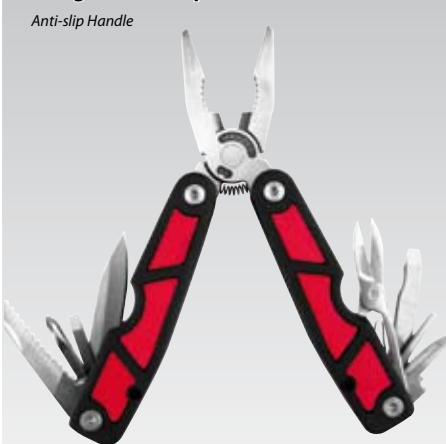

14 en 1

MHMA-14

Navaja Multiusos

Multipurpose Knife



Largo / Length: 6"
Incluye funda de nylon.
Includes nylon pouch.

15 en 1

MH-151

Mango de Aluminio

Aluminum Handle



Incluye 11 puntas
destornilladoras.
Includes 11 bits.

25 en 1

MHAL-25

Mango de Lujo

De luxe Handle



Incluye 11 puntas
destornilladoras.
Includes 11 bits.

25 en 1

MHML-25

Navaja Multiusos

Multipurpose Knife



Largo / Length: 7"
Incluye funda de nylon y
11 puntas destornilladoras.
Includes nylon pouch
and 11 bits.

28 en 1

MH-281



Navaja Multisusos

Multipurpose Knife



Largo / Length: 7"
Incluye funda de nylon y
11 puntas destornilladoras.
Includes nylon pouch
and 11 bits.

27 en 1

MH-271

Navaja Multisusos

Multipurpose Knife



Largo / Length: 7"
Incluye funda de cuero y
11 puntas destornilladoras.
Includes leather pouch
and 11 bits.

27 en 1 de Lujo
Deluxe

MH-271L

Kit para Viaje

Travelling Kit



Incluye navaja 6 en 1.
Includes 6 in 1 knife

23 en 1

MHN-231

Con Lámpara

With LED light



10 en 1

MHL-101

Kit Multisusos Navaja con Lámpara

Multitool, knife and lamp kit



Incluye:
Multiherramienta 15 en 1
Navaja multisusos 15 en 1
Lámpara con Led

Incluye:
Multitool 15 in 1
Multipurpose Knife 15 in 1
Led torch

3 en 1

KMNL-3

Kit Multiherramientas Con Lámpara

Multitool kit with lamp



Incluye:
Multiherramienta 15 en 1
Navaja multisusos 15 en 1
Mini navaja 5 en 1
Mini lámpara
Baterías Incluidas

Incluye:
Multitool 15 in 1
Multipurpose Knife 15 in 1
Mini knife 5 in 1
Mini Lamp
Batteries included

4 en 1

KML-41

Kit Navaja, Brújula y Lámpara

Switch blade, compass and lamp kit



Incluye funda de nylon
Includes nylon pouch

KNBL-3

Tijera Multisusos

Multipurpose Knife



4 en 1

TMU-41

Maletas para herramientas TOOL BAGS

Tipo diagonal

Dimensiones/Dimensions: 4 x 35 x 48 cm
Diagonal tool bag



11 Compartimentos **MHD-13**

Tipo cubeta

Dimensiones/Dimensions: 27 x 27 x 34 cm
Bucket tool bag



29 Compartimentos **MHTC-1**

Tipo Rectangular

Dimensiones/Dimensions: 35 X 13 x 17 cm.

Correas de mano de gran resistencia.
Carrying straps of great resistance.
Rectangular tool bag



5 Compartimentos **MH-5**

Tipo Triangular

Dimensiones/Dimensions: 27 X 156 x 25 cm.

Correas de mano y al hombro.
Straps for hands and shoulder.
Triangular tool bag



16 Compartimentos **MHG-16**

Tipo Triangular

Dimensiones/Dimensions: 37 X 23 x 20 cm

Correas de mano de gran resistencia.
Carrying straps of great resistance.
Triangular tool bag



17 Compartimentos **MH-17**

Tipo triangular con ruedas

Dimensiones/Dimensions: 29 x 57 x 33 cm.
Triangular tool bag with wheels

Todas las maletas tienen material
nylon 600 d reforzado.
All baggages have reinforced nylon
material 600 d.

Correas de mano y al hombro
Straps for hands and shoulder.
Rueda de alta resistencia.
High resistance wheel.



30 Compartimentos **MHCR-1**

Banco plegable con depósito para herramientas

Foldable chair with tools bag
with 22 compartments



22 Compartimentos **BPDH-90**